

# Standard Component Details

Where no production information has been provided, Cumbrian Stone has allowed to manufacture the stone components shown on your quotation to the below details. Any variation to the below details must be confirmed prior to your order entering production, and Cumbrian Stone accepts no liability for any costs arising as a result of details not being checked and confirmed prior to manufacturing.

## Cills

Square Cill - No Weathering  
Stone Reference: C...

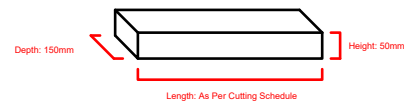

Drip Required - No

Slip Cill  
Stone Reference: C...

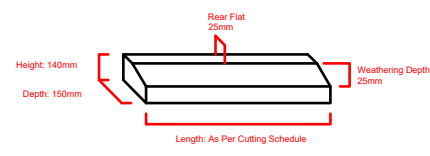

Drip Required - No

Stooled Cill  
Stone Reference: C...

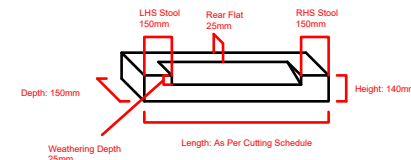

Drip Required - No

Stooled Cill - Mullion Window  
Stone Reference: C...

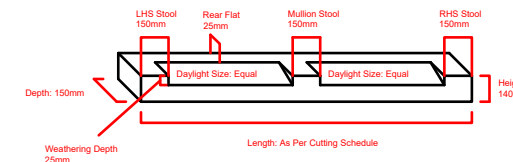

Drip Required - No

## Heads / Lintels

Plain Head - Square Section  
Stone Reference: L...

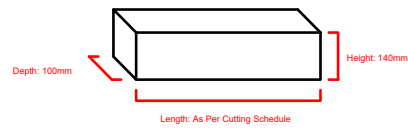

Rebate Required - No

Chamfered Head  
Stone Reference: L...

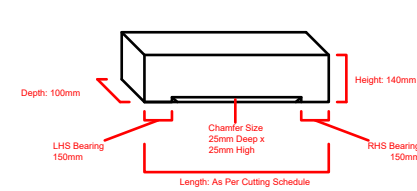

Rebate Required - No

Chamfered Head - Two Light Window  
Stone Reference: L...

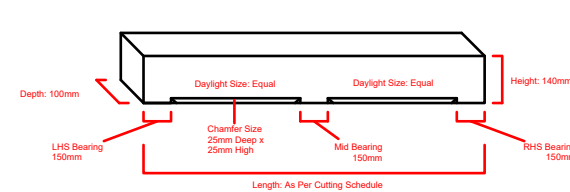

Rebate Required - No

## Jambs and Mullions

Plain Jamb/Mullion - Square Section  
Stone Reference: Jamb - J... Mullion - M...

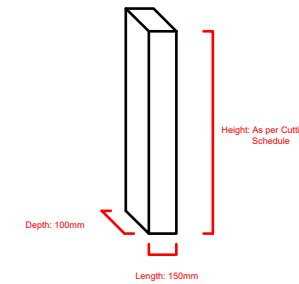

Rebate Required - No

Chamfered Jamb  
Stone Reference: J...

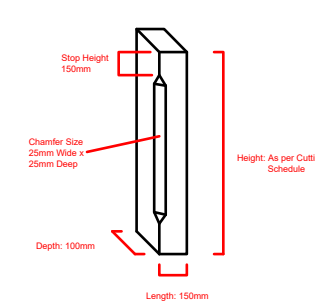

Rebate Required - No

Chamfered Mullion  
Stone Reference: M...

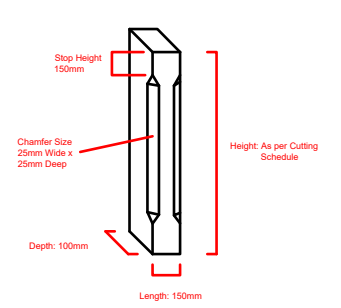

Rebate Required - No

## Quoins

Plain Quoin - Square Section  
Stone Reference: Q...

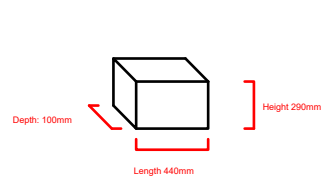

L Shaped Quoin - Square Section  
Stone Reference: Q...

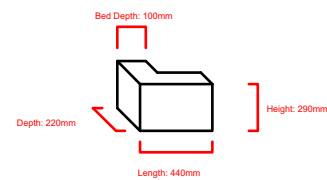

## Copings

Flat Coping - Square Section  
Stone Reference: CO...

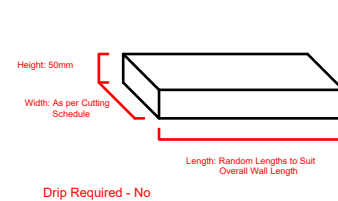

Drip Required - No

Once Weathered Coping - Straight  
Stone Reference: CO...

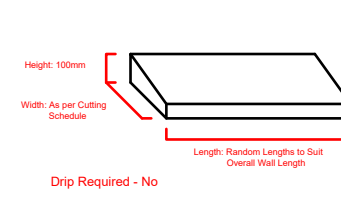

Drip Required - No

Twice Weathered Coping - Straight  
Stone Reference: CO...

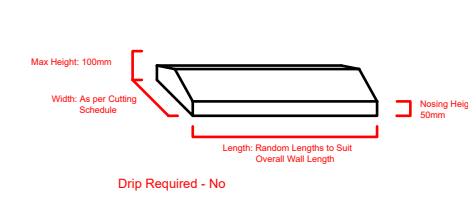

Drip Required - No

Chamfered Coping - Straight  
Stone Reference: CO...

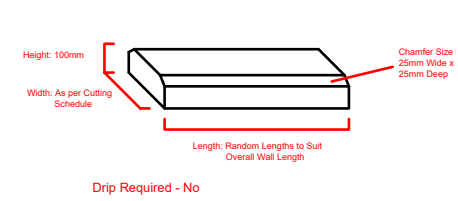

Drip Required - No

## Plinth Stones

Plain Plinth - Square Section  
Stone Reference: P...

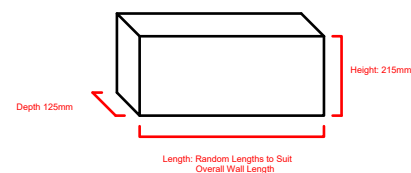

Chamfered Plinth - Straight  
Stone Reference: P...

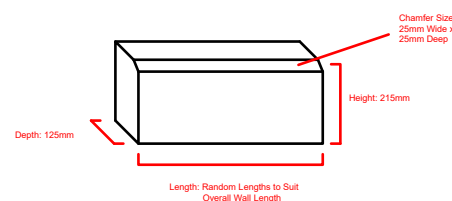

## Paving

Plain Paving  
Stone Reference: PA...

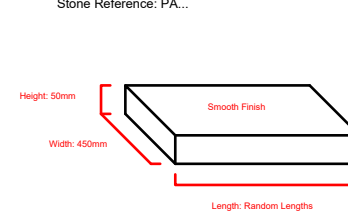

## Ridge Stones

Angled Ridge  
Stone Reference: R...

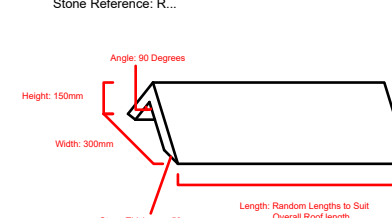

 <h1 style="margin: 0;">Cumbrian Stone</h1> <p style="margin: 0;">Natural Stone Specialists</p>	
<b>CONTRACT TITLE</b>	
<b>Standard Component Details</b>	
QUOTE / DWG REF:	STANDARD 2018
DRAWN BY:	Sam Morris
DATE:	30/05/2018